

MMJ-A1

Specifications

Model No.	MMJ-A361	MMJ-A481	MMJ-A601
Capacity	0.36 L / 12.2 oz	0.48 L / 16.2 oz	0.60 L / 20.3 oz
Heat retention (1 hour)	Greater than 85°C / 185°F	Greater than 86°C / 186°F	Greater than 87°C / 188°F
(6 hours)	Greater than 62°C / 143°F	Greater than 67°C / 152°F	Greater than 71°C / 159°F
Cold retention (6 hours)	Less than 9°C / 49°F	Less than 8°C / 47°F	Less than 7°C / 45°F
Size*	W 6.6 x D 7.2 x H 17.6 cm W 2.60 x D 2.83 x H 6.93 inch	W 6.6 x D 7.2 x H 21.8 cm W 2.60 x D 2.83 x H 8.58 inch	W 6.6 x D 7.2 x H 26.0 cm W 2.60 x D 2.83 x H 10.24 inch
Weight*	0.17kg / 0.37 lbs	0.19kg / 0.42 lbs	0.23kg / 0.51 lbs

*Approximate value

- ※ Heat retention has been calculated under the condition of adding hot water at 95°C ±1°C / 203°F±2°F and leaving it in a room temperature of 20°C±2°C / 68°F±4°F for 1hour or 6hours.
- ※ Cold retention has been calculated under the condition of adding cold water at 4°C ±1°C / 39°F±2°F and leaving it in a room temperature of 20°C±2°C / 68°F±4°F for 6hours.
- ※ Capacity is the actual volume of water that can be stored in the product when the stopper is closed. This is not the "Maximum level" volume described in "Safety Precautions".

Replacing and Purchasing Consumable Parts

The gasket and stopper are consumable parts. Check once a year for damage/deterioration. If heavily stained or loose, replace them.
For replacement parts, contact customer service or the shop where you purchased this product.

Before Contacting Customer Service

The utmost measures have been taken to ensure the quality of this product. However, should the product be defective, contact your dealer and provide the following information.

1. Product name
2. Model Number (bottom of the product)
3. Description of trouble (As detailed as possible)
4. Purchase date

Feel free to send any questions or comments about this product to the shop where you purchased it.

- ※ For the purpose of performance improvement, designs, specifications and parts shown in this publication are subject to change without notice.



TIGER CORPORATION

Head Office: 3-1 Hayami-cho, Kadoma City, Osaka 571-8571, Japan

TIGER CORPORATION HONG KONG LIMITED

Rm. 1006B, 10/FI., Join-in Hang Sing Centre, 71 - 75 Container Port Road, Kwai Chung, N.T.

Tel: (852) 2418-0912 Fax: (852) 2418-0911

URL : <http://tiger-corporation.hk/>

TIGER CORPORATION U.S.A.

1815 W 205th Street, Unit 106, Torrance, CA 90501

Tel: 1-866-55-TIGER (84437)

Email: support@japantigercorp.com

URL : <https://tiger-corporation-us.com>



MODEL
MMJ-A1

For household use

Stainless Steel Mug

Instructions

Thank you for purchasing a "TIGER" Stainless Steel Mug.
Please read the instructions completely before use.
Keep these instructions for future reference.

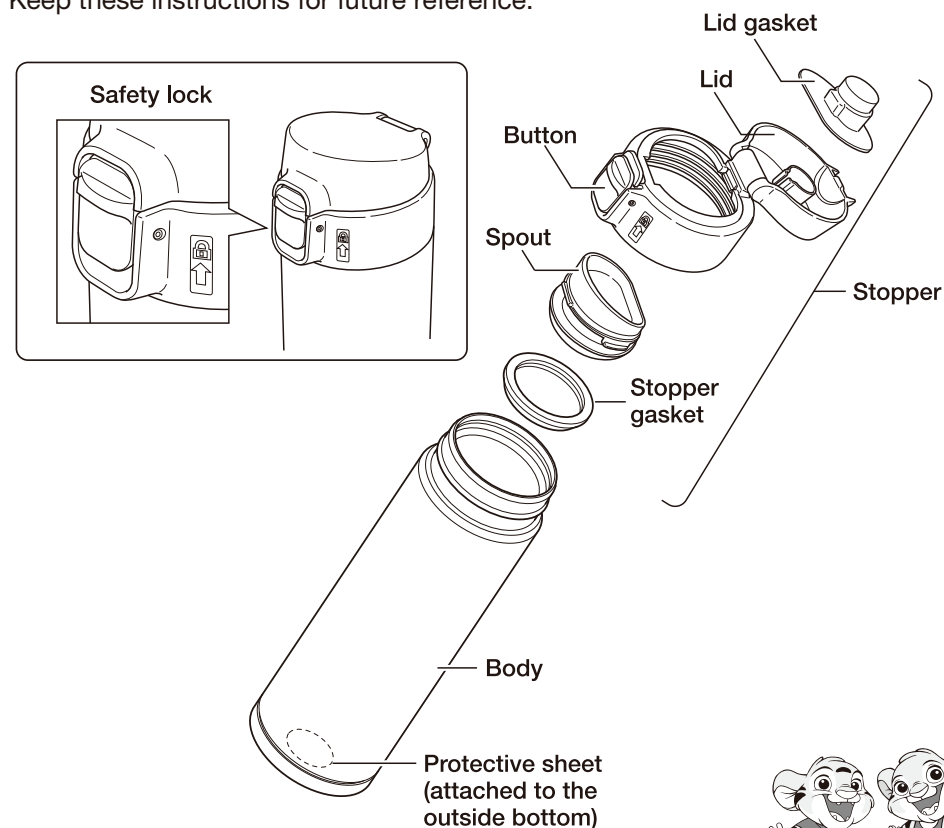



*Make sure that all parts are present before use.



Safety Precautions **Be sure to follow all instructions.**

- ◆ All safety instructions described below are intended to protect the user and other individuals from physical harm and household damage.
- ◆ Safety instructions are classified and described according to the level of harm and damage caused by improper use, as shown below.

 **Warning** This symbol indicates there is a possibility of death or serious injury.

 **Caution** This symbol indicates there is a possibility of injury or damage to property.

Description of Symbols

 This symbol indicates a prohibited action.





 This symbol indicates an action that must be taken or an instruction that must be followed.

Warning

-  **Keep out of reach of children. Do not let children play with the product.**
There is a risk of burns or injuries.







Caution

-  **Do not put dry ice or carbonated beverages in the product.**
The air pressure inside the product may increase, causing the stopper and lid to become stuck or prone to shattering, or the parts to be damaged.
-  **Be sure to set the stopper in proper position.**
Contents may leak and cause soiling or skin burns.
-  **Do not store milk, dairy products, or certain fruit juices in the product.**
The contents may decay or spoil. Long-time spoilage can create gases that raise the air pressure inside the product due to decay or spoil, causing the stopper and lid to become stuck or prone to shattering, or the parts to be damaged, and result in scattering of fragments.
-  **Do not touch the brim of the product with a kettle spout.**
The product may fall over, causing burns or injuries to the skin, or a scratch or deformation to the product.
-  **Do not place the product near stoves, open flames, or other sources of extreme heat.**
There is a risk of burns or deformation or discoloring of the product.





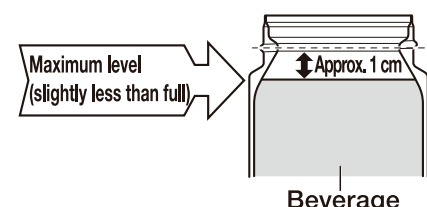

Do not remove the caution sticker on the product.

Caution

-  **Do not heat the product in a microwave oven.**
There is a risk of injury or failure due to sparks.
 -  **Do not open the lid if the product is tilted or placed near your face when it contains a hot beverage.**
This may cause the internal air pressure of the product to increase and the contents to burst out and scatter, potentially causing burns.
 -  **Drink slowly and do not tilt the product abruptly when the product contains a hot beverage.**
Do not tilt the product abruptly. This may cause the contents to burst out, potentially causing burns.
 -  **Do not use the product in a moving vehicle.**
This may result in burns or soiling of clothes or of the interior of the vehicle. (Using the product while you are driving is very dangerous, as you may be distracted.)
 -  **Be sure to fill the product with drink below the maximum level shown in the diagram.**
If the contents exceed the specified line, they may leak or overflow, potentially causing burns.
- 

Maximum level (slightly less than full) →

↑ Approx. 1 cm

Beverage
-  **Do not use the product if its ability to retain heat declines.**
Hot beverages can make the product very hot, potentially causing burns.
 -  **Do not use the product for any purpose other than keeping beverages warm or cold for drinking.**
 -  **Do not knock over, drop or expose the product to excessive shocks.**
There is a risk of damage to the product, a reduction of its heat- or cold-retention ability, rusting, flaking of the exterior paint, or leakage of contents.
 -  **Do not disassemble or attempt to repair the product by yourself.**
There is a risk of failure or accident. The contents may leak.
 -  **Do not put the product in a freezer.**
Contents may leak or the product may be damaged.
 -  **Do not store tea leaves or peeled fruit.**
They may clog the spout, resulting in leakage of the contents.

How to Use

⚠ Caution

- ❗ **Be sure to clean the product immediately after use, especially after consuming sports drinks.**
Rinse the inside of the product well, even if you are going out, for example, and don't have time to wash it thoroughly. Mold, rust, or holes may appear.
- ⊘ **Do not store soups or beverages containing salt in the product.**
The product may become decayed, spoiled, or rusted.
- ⊘ **Do not leave the product in a bag for a long time.**
The storage conditions may change and there is a risk of rust or odors.
- ⊘ **Do not place the product in a bag if its exterior is wet.**
There is a risk of rust, odor, or soiling.
- ⊘ **Do not use chlorine-based bleaches.**
This may cause rusting, flaking of the exterior paint, or a hole on the product.
- ⊘ **Do not remove the protective sheet on the underside of the product.**
Removing this may reduce the product's heat- or cold-retention ability.
- ⊘ **Do not scrape or rub the patterns, plated buttons, and stickers on the surface of the product using your nails or a hard object.**
The exterior paint may come off.
- ⊘ **Do not pour the beverage into the bottle while the stopper is set.**
The contents may leak or the product may fall over, causing burns or injuries to the skin. The product may also be scratched or deformed.
- ❗ **Be sure to wipe spilled beverage on spout.**
The contents may leak when the lid is closed.

For can holder

- ❗ **Before using the can holder, check its intensity.**
If the holder is not strong enough, it may come off and get damaged. This may result in burns or soiling of clothes or of the interior of the vehicle.
- ❗ **When using a commercially available can holder, use the stationary type.**
If the suspension holder that is attached to the window or air conditioning outlet is used, it may come off. This may result in burns or soiling of clothes or of the interior of the vehicle.

Before the first use

● Cleaning

You may notice an unusual odor coming from the material of the product.

In this case, clean the product by following the steps below.

- (1) Check that the lid gasket and stopper gasket are attached to the stopper.
- (2) Pour hot water into the body and securely close the stopper and lid.
- (3) Hold the body and gently shake it several times to rinse the inside thoroughly. (Do not shake it excessively. The hot water may splash out, potentially causing burns.)
- (4) Discard the hot water, and then clean each part.

1 Turn the stopper to remove it.

- Check that the lid gasket, stopper gasket and spout are attached to the stopper.

2 To keep your beverage warm/cool longer, first pour a small amount of hot/cold water into the main body and let it sit for one or two minutes.

- Discard the hot/cold water after preheating/precooling.

3 Pour your hot/cold beverage into the main body.

- Pour appropriate amount of beverages.
- Do not insert large cubes of ice. Use small cubes or crushed ice.

4 Place the main body in an upright position and turn the stopper to close it.

- Turn the stopper as far as it will go to securely close it.

5 Slide down the safety lock, push the button to open the lid, and then drink beverage.

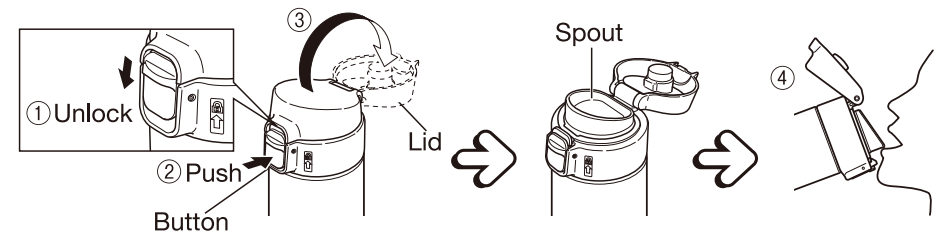

Caution

- Do not push the button while tilting the body. Liquid may splash out of the bottle.
- Do not tilt the body immediately after pouring in a hot beverage and closing the lid. The contents may leak.

6 After drinking the beverage, keep the product in an upright position and securely close the lid. Slide up the safety lock.

Caution ● Make sure the product does not suffer any strong impact while carrying it. The lid may open.

- If you place the product in a bag, make sure it is upright to prevent any accidental leakage. The product may leak if you place it on its side.
- If you place the product in a bag, make sure the button keeps away from bag contents. The lid may open.

How to Clean

- ◆ Clean the product on the same day after every use.
- ◆ Use mild kitchen detergent (for table or cookware).
- ◆ Use a soft sponge or cloth.
- ◆ Clean the product thoroughly to prevent any odor.

(1) Wash each part using a sponge with diluted detergent water or lukewarm water, and then thoroughly rinse it with water.

(2) Wipe the water off with a dry cloth and dry the parts thoroughly.

Caution ● Do not soak the body and lid when washing them. (Water may enter.)

- After washing the whole body, immediately use a dry cloth to wipe off the moisture on its outer surface. Not wiping off all droplets could leave water stains or cause rust and other marks.
- Do not use thinners, cleansers, bleaches, cleaning wipes, metallic scrubbing brushes, or nylon scrubbing brushes.
- Do not use a dishwasher or dish dryer, and do not wash with boiling water. (Except gasket)
- Be sure to attach the gaskets and spout.
- Dry the body and lid completely after removing stains when not in use for a long time.

If an odor remains on the gasket

Depending on the contents, the odor may remain on the gasket. In this case, leave the gasket in boiling water for approximately 30 minutes to reduce the odor. If the odor is still noticeable, purchase a new gasket (sold as an optional part).

Attaching and Removing the gasket

Caution ● Do not attach the gasket in the incorrect place or direction. The contents may leak.

Attaching and Removing the lid gasket

To remove Lid gasket
Lid
Slowly remove the lid gasket while holding and turning it.

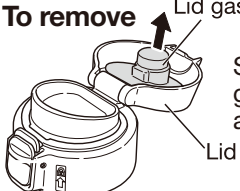

To attach
When attaching the lid gasket, make sure to fit it completely in the proper direction.

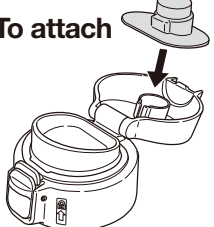

Attaching and Removing the spout

To remove Spout
Hinge
Spout can not be removed, even if its front side is pushed.
Push the hinge side slowly to remove.



To attach Spout
After fitting the front side of spout, set the hinge side.
Make sure the spout is fixed.

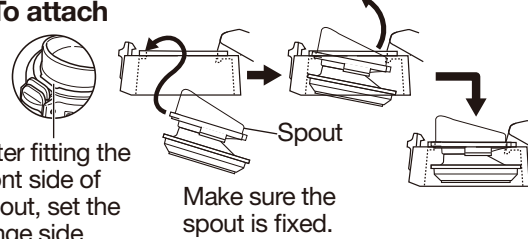

Attaching and removing the stopper gasket

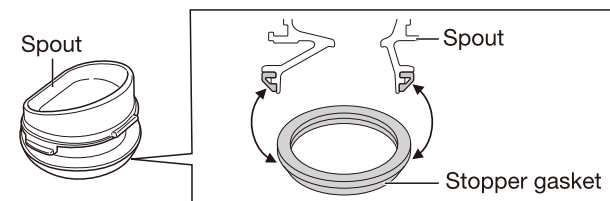

Slowly remove the stopper gasket while holding its edge.
When attaching the stopper gasket, make sure to fit it completely in the proper direction.

If marks start to become visible on the inside of the main body

For red, rust-like spots or rough areas

Such staining can be caused by minerals in water, such as calcium, magnesium, and iron. It is recommended to clean them with citric acid, which is available at supermarkets and drug stores.

- (1) Dilute the citric acid (approximately 10 g) in lukewarm water, and then pour it into the main body.
- (2) After a few hours have elapsed, wash the main body with a soft brush and then thoroughly rinse it.
- (3) Dry the main body completely.

Note: Do not use detergents for other brands' pots or insulated bottles. The gasket may be broken.

MMJ-A1

規格

型號	MMJ-A361	MMJ-A481	MMJ-A601
容量	0.36L	0.48L	0.60L
保溫效力	85度以上 (1小時)	86度以上 (1小時)	87度以上 (1小時)
	62度以上 (6小時)	67度以上 (6小時)	71度以上 (6小時)
保冷效力	9度以下 (6小時)	8度以下 (6小時)	7度以下 (6小時)
	9度以下 (6小時)	8度以下 (6小時)	7度以下 (6小時)
外型尺寸*	寬度6.6×深度7.2×高度17.6cm	寬度6.6×深度7.2×高度21.8cm	寬度6.6×深度7.2×高度26.0cm
重量*	0.17kg	0.19kg	0.23kg

* 表示大概的數值。

※保溫效力為以室溫在20度±2度的條件之下，裝滿熱水並直放的狀態，從水溫在95度±1度起算置放1小時及6小時後該熱水溫度。

※保冷效力為以室溫在20度±2度的條件之下，裝滿冰水並直放的狀態，從水溫在4度±1度起算置放6小時後該冰水溫度。

※實際容量是指安裝好產品附屬杯蓋的狀態下可實際放入的容量。並非是「安全注意事項」中所記載的「到這個位置」。

消耗品更換·洽購

中栓為消耗品。請以一年為基準做確認。
欲購買零件，請洽詢至原購買處或客戶服務中心。

產品諮詢相關

我們對於品質上的管理非常嚴謹，萬一產品上有出現瑕疵時，請洽詢原購買處或虎牌客服中心，並提供以下資訊。

1. 產品名稱
2. 型號 (標示於本體底部的貼紙)
3. 產品狀況 (請詳細描述)
4. 購買日

對於產品上有任何問題，歡迎洽詢。

※為了提升功能品質，本書所記載的設計、規格及零件將有部分可能會無預期進行變更。

 **TIGER 虎牌**

TIGER CORPORATION
Head Office: 3-1 Hayami-cho, Kadoma City, Osaka 571-8571, Japan

委製商

TIGER CORPORATION

日本国大阪府門真市速見町3番1号

電話 : +81(6)6906-2124(代表號)

進口商·代理商

虎記股份有限公司

台南總公司

聯絡地址：台南市南區新樂路63號

台北分公司：台北市中正區紹興北街3號2樓

台中分公司：台中市南區忠明南路705號

台南直營店：台南市南區金華路二段310號

高雄直營店：高雄市苓雅區中正一路146號

免費服務專線：0800-888-572

網址：http://www.tiger-corporation.tw

電話：(06) 2655899(代表號) 傳真：(06) 2647707

電話：(02) 23971179 傳真：(02) 23975737

電話：(04) 23754627 傳真：(04) 23754502

電話：(06) 2200855

電話：(07) 7161460

 **TIGER 虎牌**

型號

MMJ-A1

家庭用

不銹鋼保溫保冷杯

使用說明書

感謝您購買本公司產品。請在使用前，務必詳讀使用說明書，並請放在使用者能隨時參閱的地方妥善收存。

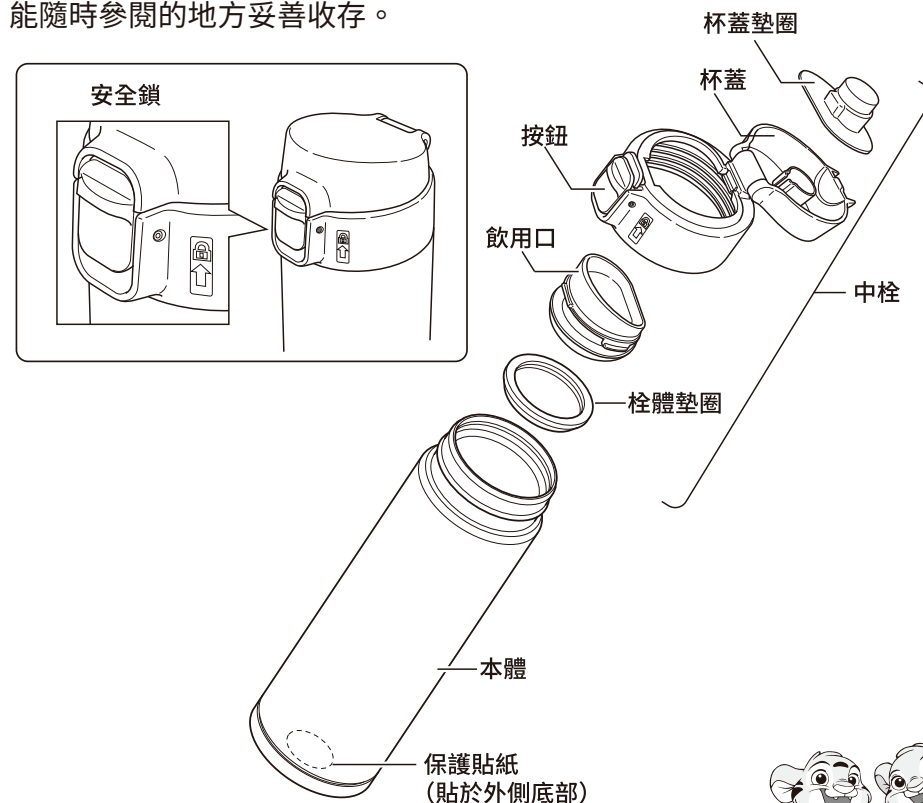

※使用前請確認各部件是否齊全。



安全注意事項

請務必遵守

- ◆ 以下說明了為防止對使用者或他人造成人身傷害或財產損害而必須遵守的事項。
- ◆ 關於因操作錯誤而導致的危害及損害的程度，按以下分類進行說明。

警告 可能會導致死亡或重傷的內容。

注意 可能會造成使用者受害或財物受損的內容。

所用圖形符號的說明

 不可實施的“禁止”內容。





 必須執行的“指示”內容。

警告

-  請勿置放於幼兒易拿取的地方。注意不要讓孩童玩耍或使用。否則可能導致燙傷或受傷等。



注意

-  請勿裝入乾冰・碳酸飲料等。
可能發生內壓上升、中栓或杯蓋打不開、杯中液體噴出、零件受損的情況，導致受傷等。
-  請確認中栓已拴緊。
否則可能導致杯中液體滲漏，造成燙傷或弄髒其他物品。
-  請勿裝入牛乳・乳製飲料・果汁等。
否則會導致液體腐壞、變質。外，長時間放置時，液體的腐壞、變質會導致氣體產生而使本體內壓上升，可能會有打不開中栓或杯蓋、杯中液體噴出、零件受損飛散等危險。
-  注水時，請勿讓水壺等容器抵住本體的肩部。
否則可能使杯體翻倒，導致燙傷、受傷或本體受損、變形。
-  請勿置放於瓦斯爐火及暖爐等火源高溫處。
否則會導致燙傷，本體變形、變色。

請勿撕下貼在本體上的相關注意事項貼紙。

注意

-  請勿使用微波爐加熱。
會造成火花飛濺，導致受傷和設備故障。
-  在已裝入熱飲時，請勿於傾斜狀態下或靠近臉部的狀態下打開中栓的蓋子。
否則可能導致本體內壓上升、熱飲急速噴出或飛濺而造成燙傷等。
-  飲用熱飲時，請注意避免突然傾斜本體，並慢慢飲用。
如果突然傾斜杯體，杯中飲料會急速流出，可能導致燙傷等。
-  汽車行駛中請勿使用。
否則可能導致燙傷或車內、衣服被弄髒。(如果是駕駛員，會分散開車時的注意力，非常危險。)
-  飲料食物的量，請加至圖示所標記位置。
若裝入過多的飲料，可能導致滲漏、溢出，造成燙傷。

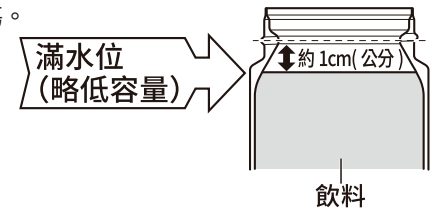

-  當此產品的保溫效能失效，請勿繼續使用。
裝入熱的飲品食物，會使本體變熱，有可能造成燙傷的危險性。
-  請勿使用於飲品保溫・保冷以外之用途。
-  請勿翻倒、摔落地面或撞擊等強烈衝擊。
否則可能導致杯體破損、保溫(保冷)效果失效、生鏽、塗層剝落、杯中液體滲漏。
-  請勿自行拆解或修理。
否則會導致故障、事故。以免內容物漏出。
-  請勿將保溫保冷杯放入冷凍室內。
否則可能導致杯中液體滲漏或杯體破損。
-  請勿將茶葉、果肉等裝入杯中。
否則可能導致滲漏。

使用方法

⚠ 注意

- ❗ 若裝入運動飲料，飲用完畢後請儘速清洗。
外出等情況下，即使無法充分清洗，也請立即用水沖洗本體內側。否則可能導致發霉、生鏽、孔蝕等故障。
- ⊘ 請勿裝入味噌湯或濃湯等含有鹽分的湯汁。
否則可能導致液體腐壞、變質、生鏽。
- ⊘ 請勿將本產品長時間放置於包包或袋子中。
受周圍環境(濕度、鹽分)等的影響，可能導致保溫保冷杯生鏽、產生異味。
- ⊘ 本體外側潮濕的狀態下，請勿放入提袋等。
否則可能導致保溫保冷杯生鏽、產生異味或弄髒其他物品。
- ⊘ 請勿使用含氯漂白劑。
否則可能導致保溫保冷杯生鏽、塗層剝落、孔蝕。
- ⊘ 切勿撕下貼在本體底部的保護貼紙。
撕下貼紙可能會降低保溫(保冷)效果。
- ⊘ 請勿用指甲或硬物刮擦本體的花紋、按鈕的金屬鍍膜和貼紙。
否則可能導致花紋、貼紙剝落。
- ⊘ 請勿在中栓已設置好的狀態下倒入飲品。
否則可能會使內容物漏出、使杯體翻倒，導致燙傷、受傷或本體受損、變形。
- ❗ 請將杯口殘留的飲品擦拭乾淨。
關上中栓的時候可能會漏出。

使用杯架時

- ❗ 使用杯架時，請事先確認強度後再使用。
強度不足時，杯架可能會鬆脫、破損，進而導致燙傷或車內、衣服被弄髒。
- ❗ 市售的杯架請使用固定放置型。
如果使用安裝在車窗或空調出風口的吊掛型杯架，杯架可能會鬆脫，進而導致燙傷或車內、衣服被弄髒。

初次使用時

● 清洗

有時會散發產品材料特有的氣味。
此時請按照以下步驟清潔保養。

- ① 確認有附上墊圈。
- ② 在本體裡裝入熱水，並確實擰緊杯蓋。
- ③ 握住本體，重複數次徹底沖洗內側的動作。(切勿施加強烈振動。以免熱水噴出造成燙傷。)
- ④ 倒掉熱水，對各部分進行清潔保養。

1 取下中栓。

- 確認杯蓋墊圈、栓體墊圈、飲用口附在中栓上。

2 如想提高保溫(保冷)效果，請先裝入少量熱水(冷水)，預熱(預冷)1-2分鐘。

- 預熱(預冷)後，倒掉熱水(冷水)。

3 注入熱飲(冷飲)。

- 請勿裝入過多(量)飲品。
- 在放入大的冰塊時，請不要整個塞入，請先將其分成小塊再放入。

4 請使本體保持豎直狀態，擰緊中栓。

- 將中栓擰緊到不能旋轉為止，確認其已擰緊。

5 下滑安全鎖，按下按鈕後打開杯蓋飲用。

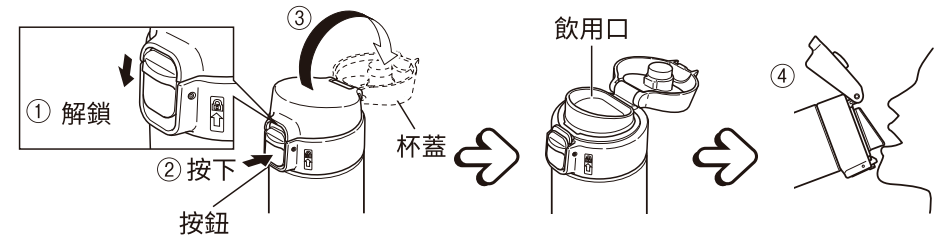

請注意

- 請勿在本體傾倒的狀態下按下按鈕。否則熱飲可能會一口氣流出來。
- 將熱飲倒入本體並緊中栓後，請勿讓本體傾倒。以免內容物漏出。

6 飲用完後，使本體保持豎直狀態，確實擰緊杯蓋。上壓安全鎖。

請注意

- 攜帶時請勿施予強力的撞擊。否則可能會使杯蓋打開。
- 裝入包內時，為防止滲漏，請豎直放入本體。如果橫放，有可能滲漏。
- 當放入提袋、背包..等，請注意勿碰撞到按鈕。否則可能會使杯蓋打開。

清潔保養的方法

- ◆使用後，請務必於當日內清洗。
- ◆清潔劑請使用廚房用合成清潔劑（餐盤用、調理器具用）。
- ◆使用海綿、布等柔軟的清洗用具。
- ◆為避免殘留異味，請經常清洗。

- ①用水或溫水稀釋清潔劑，使用海綿清洗，並用清水徹底沖洗。
- ②用乾抹布擦除水分，並使其充分乾燥。

請注意

- 請勿將本體、杯蓋浸泡清洗。（可能會讓水進入）
- 本體沖洗乾淨後，請立即用乾布擦除水分。若不擦乾，會留下“水滴”痕跡，造成生鏽或弄髒其他物品。
- 請勿使用稀釋劑、去污粉、氯系漂白劑、化學抹布、金屬刷、尼龍刷等物品進行清洗。
- 請勿使用洗碗機或烘碗機等或用水煮沸清洗。（會讓墊圈剝離）
- 請務必裝上墊圈、飲用口。
- 長時間不使用時，請充分洗淨污垢，並使其乾燥。

墊圈有異味時

因裝入的內容物不同，墊圈會因而附著異味。此時，將墊圈放入沸水中煮30分鐘左右，氣味會減輕，但若仍然介意異味的話，請洽購另售的墊圈。

墊圈拆卸方法・安裝方法

請注意 ●請勿弄錯墊圈的安裝位置與方向。以免內容物漏出。

杯蓋墊圈拆卸方法・安裝方法

■拆卸方法



■安裝方法

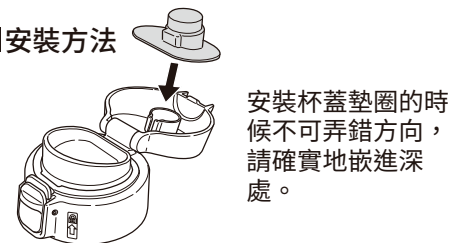

飲用口拆卸方法・安裝方法

■拆卸方法

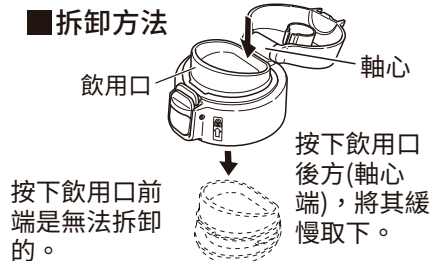

■安裝方法

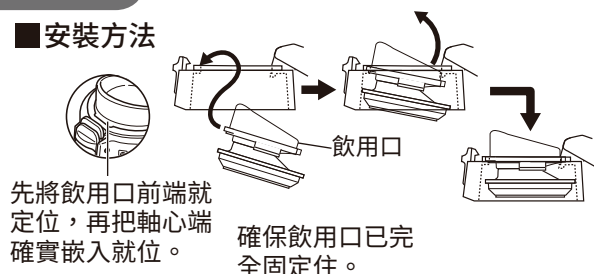

栓體墊圈拆卸方法・安裝方法

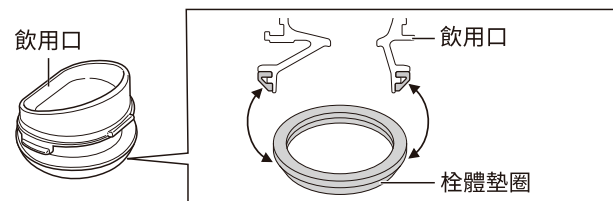

本體內側的髒污變得很明顯時...

出現「類似生鏽的紅色斑點」及「粗糙物(水垢)」的情況

因水中含有的礦物質成分(鈣、鎂、鐵分等)產生的髒污。建議使用檸檬酸清洗此類髒污。

- ①用溫水稀釋檸檬酸(約10g)，放入本體。
- ②靜置2~3小時後，用柔軟的刷子清洗乾淨，並用水徹底沖洗。
- ③充分乾燥。

※請勿使用不明成分清潔劑清洗。否則墊圈可能會損壞。